



# SE545 SE546

Hand Operated Hand & Foot Operated

## Installation, Maintenance and Operating Instructions

Manufactured by PBA Safety in Australia to comply with AS 4775 - 2007.

### DESCRIPTION

Floor mounted EMERGENCY AERATED EYE WASH unit. Eye wash is supplied with a 15mm stay open full flow ball valve, activated by an activation paddle handle and foot pedal.

#### EYE/FACE WASH

Eye/Face Wash: Aerated Eyewash  
 Valve: 15mm Stainless Steel  
 Activator: 304 Stainless Steel Push Handle  
 Base Plate: 304 Stainless Steel

#### FLOW DATA

Eye/Face Wash  
 Flow Pressure: 138 KPa  
 Flow Rate: 12 LPM

### INSTALLATION

After unpacking carton, ensure all components are present. Mark out the floor and mount the base plate using suitable anchors. Place supplied washer on top of pedestal stand. Attach bowl assembly by aligning pin on bottom of the bowl assembly with the slot on the top of the pedestal stand. Screw in drain with provided Allen key. Fit activation handle and foot pedal (SE546). Once the unit is completely assembled connect water supply to 15mm BSPFemale connection.



Failure to use potable water can result in emergency units producing impure or contaminated water causing possible further injury. Test unit.

### TESTING

The Australian Standards AS4775-2007 states that all safety equipment shall be activated on a weekly basis to flush the line and verify proper operation. All units include a testing tag to be filled out weekly.

**NOTE:** This unit should be connected to an uninterrupted source of potable water, no less than 15mm with a minimum flowing pressure of 138KPa and a maximum static pressure of 860 KPa.

### OPERATION

The eye wash is activated by pushing the paddle handle back 90 degrees. The unit will operate until the paddle handle is manually pulled to the off position.

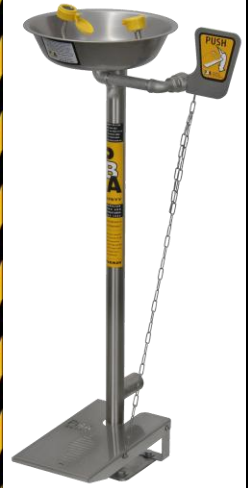
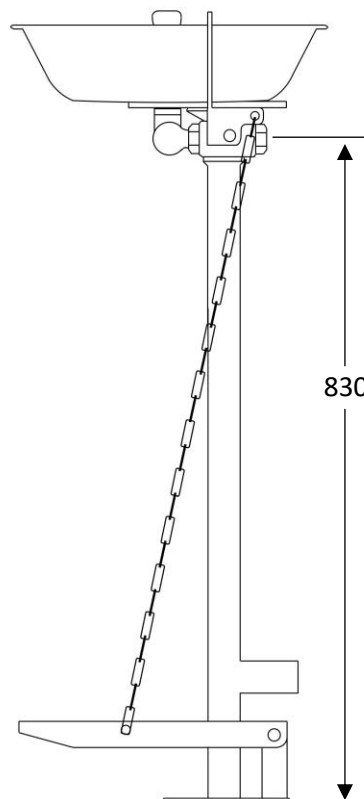
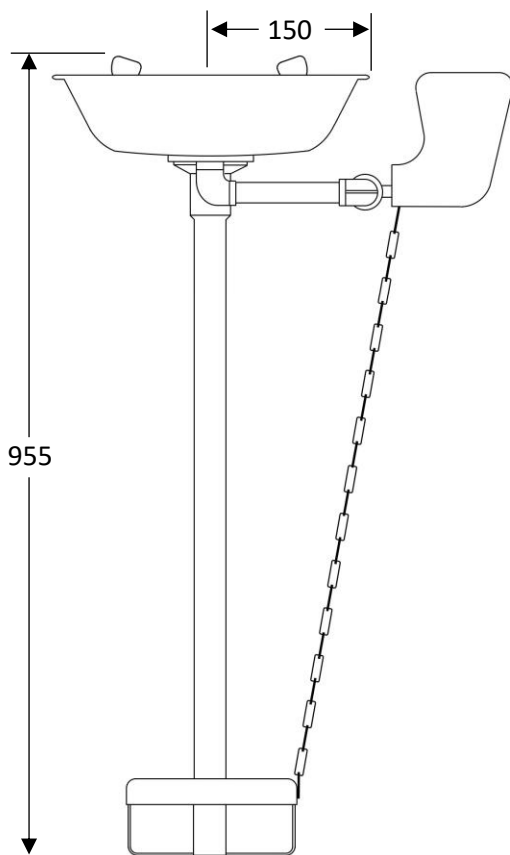

SE546 / SE545  
 Pedestal Mounted  
 Aerated Eye Wash

**WARNING:** Use only genuine Speakman parts when replacing or repairing components.

# Installation, Maintenance and Operating Instructions

## MAINTENANCE

Should you need to repair this unit, please see the parts list for correct part numbers. Before any maintenance is done **be sure the water supply is shut off.**

## MAINTENANCE SCHEDULE

Activate eyewash unit and allow water

### Weekly

to flow for 30 seconds to flush line.

Ensure water flows evenly from both outlets.

Ensure water is clean.

### Yearly

Ensure unit complies with AS 4775 – 2007.

- ① **Part No: RPG05-1177**  
Aerator Screen & Cap Assembly



- ② **Part No: SA 01003**  
Complete Bulls Horns Assembly

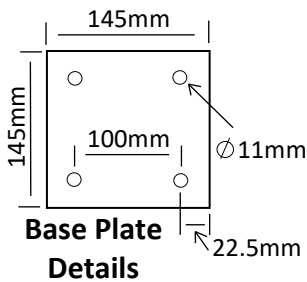
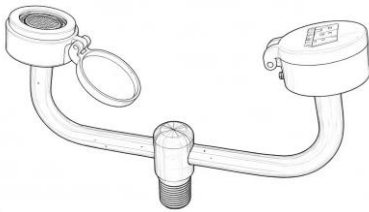

## SPARE PARTS LIST

No:	Description:	Part No:
1.	Aerator, Screen & Cap Assembly	RPG05-1177
2.	Complete Bull Horns Assembly	SA 01003
3.	Dust Cap Assembly	SA 01008
4.	Pedestal Frame	SA 01001
5.	15mm Ball Valve & Push Handle	SE 910H
6.	Foot Pedal Connection Chain	SA 03014
7.	Foot Pedal Assembly	SA 03001
8.	Stainless Steel Bowl	SR 03006

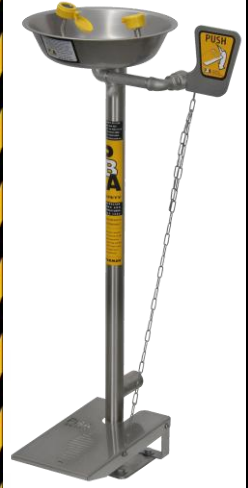
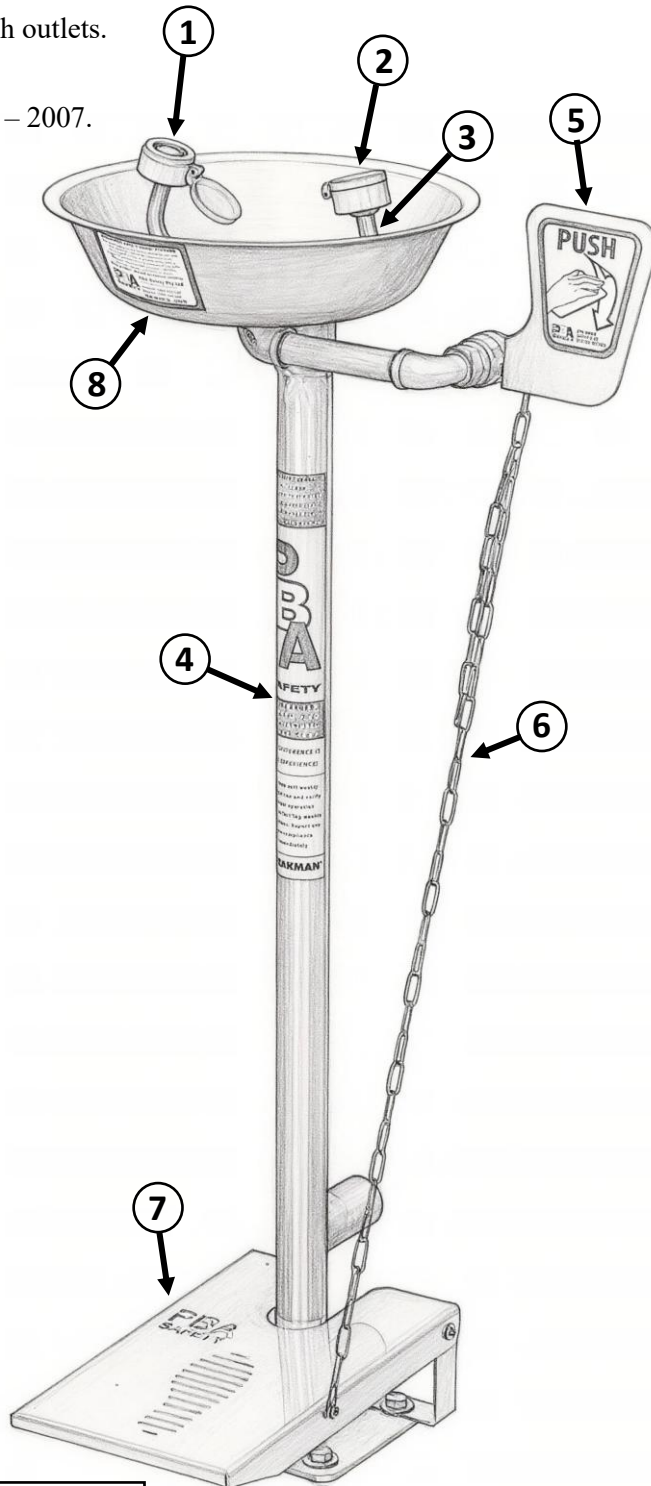

**SE546 / SE545**  
**Pedestal Mounted**  
**Aerated Eye Wash**

**WARNING:** Use only genuine Speakman parts when replacing or repairing components.