

AU25712OP

50 Litre Organic Peroxide Storage Cabinet



PBA Safety Code – AU25712OP

Organic Peroxide Storage Cabinet

Complies with AS2714

50 Litre Maximum Capacity

External Size:

1005mmH x 595mmW x 465mmD

Internal Size:

765mmH x 505mmW x 375mmD

Sump Size:

150mmH x 505mmW x 375mmD

Sump Capacity: 28 Litres

Supplied with two shelves as standard.

Extra metal shelves may be added.

Product Code: AU25995

FM Approved

(Factory Mutual Insurance Endorsement)

All Justrite Storage Cabinets are manufactured to comply fully with the relevant Australian Standards.

Powder Coat paint finish provides a superior high gloss finish which minimizes the effects of corrosion and humidity. The durable finish can withstand the abrasive type of abuse as other types of finishes.

Locking Mechanism: The door is held shut by a friction-type cylinder in accordance with Australian Standard.

All cabinets are fitted with self-closing sequential closing doors allowing the left door to close, followed by the right door. This then provides a seal around the doors.

Full length door piano hinge provides a durable sealed barrier to cabinets contents. Adjustable leveling feet at all four corners.

Shelving design permits the ventilation throughout the cabinet and troughs in each shelf collects spills and directs these away from contaminating products stored on the lower shelves. Shelves are adjustable in increments of 76mm.

Each cabinet is provided standard with a 150mm deep fully sealed sump to contain spills or leaks within the cabinet.

Self-closing mechanism is housed in the roof of the cabinet. This provides additional area within the cabinet for storage and avoids damage and alignment disorder. The cabinet closure mechanism is easily adjusted by removal of the four self-tapping screws securing the roof.

Dual vents are provided with built in flash arresters. Where applicable hazardous vapours may be piped away.

Double wall thermal barrier. 1.2mm steel thickness with 40mm air wall spacing.

Most cabinets are available ex stock to meet your requirements.

10 Year Manufacturing Warranty

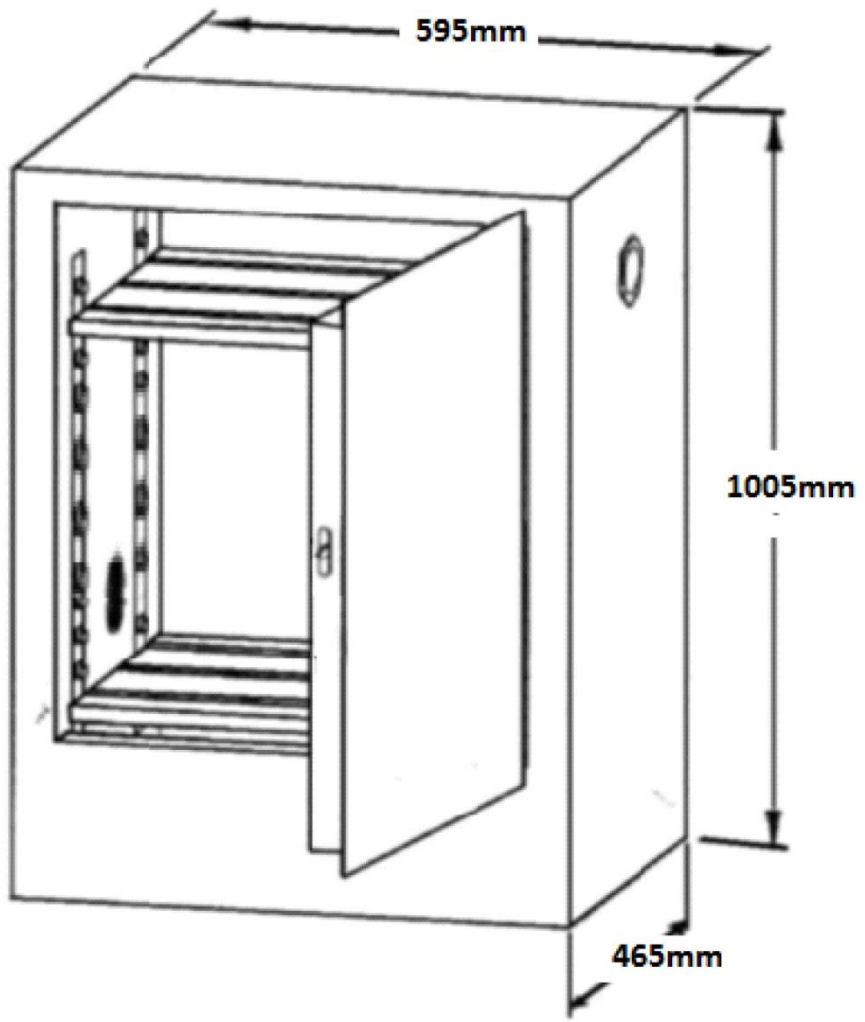

Left Side Vent Position

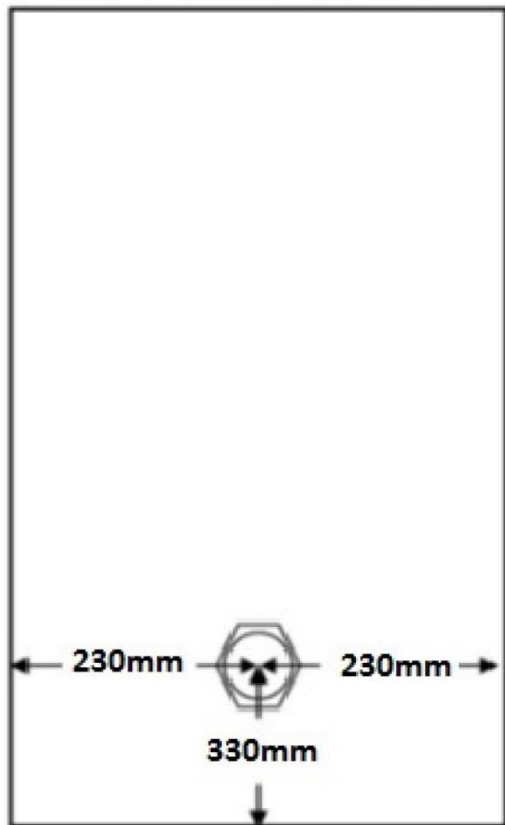

Right Side Vent Position

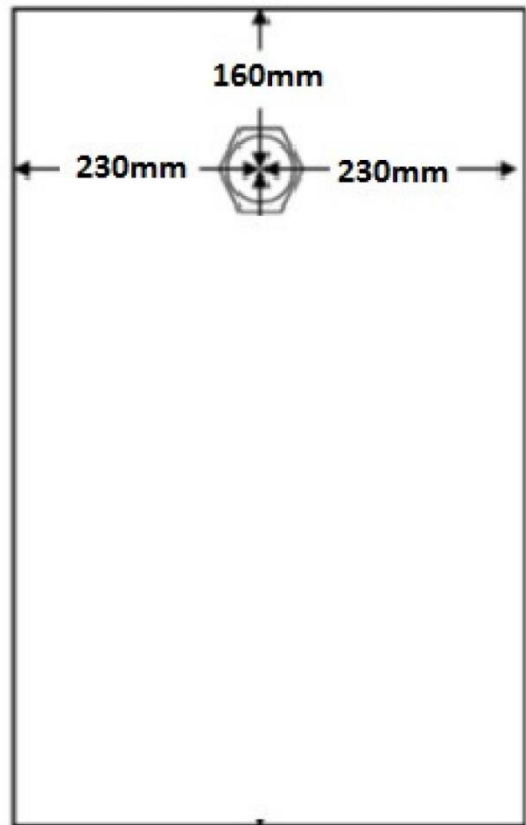

Base of Cabinet Ground Level